

Á

S



í

A



og



á ekki

skó sagði



Nafn : \_\_\_\_\_

Æfðu þig að teikna formin, teiknaðu fleiri og skreyttu þau svo alls konar. Þú getur gert rendur, doppur, andlit og hvað eina sem þér dettur í hug.

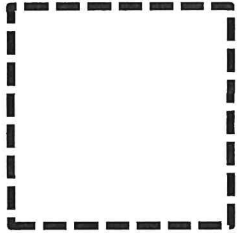
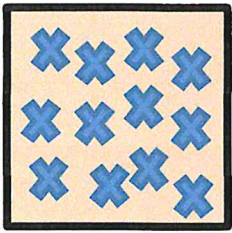

ferningur

---

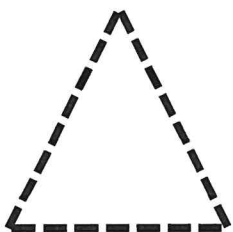
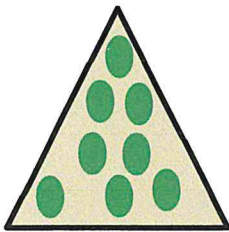

þríhyrningur

---

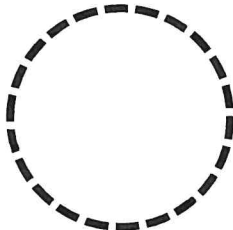
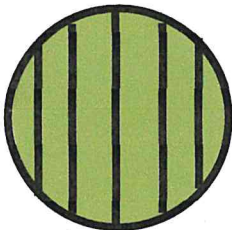

hringur

---

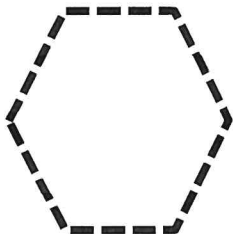
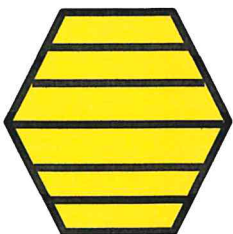

sexhyrningur

---



rétthyrningur

---

lesa

Á á

spora

Á á

skrifa

leira eða byggja



ég

og

og

bú

og

bú

ég

ég

og

og

bú

bú

og

ég

og

og

bú

## 8. Á á

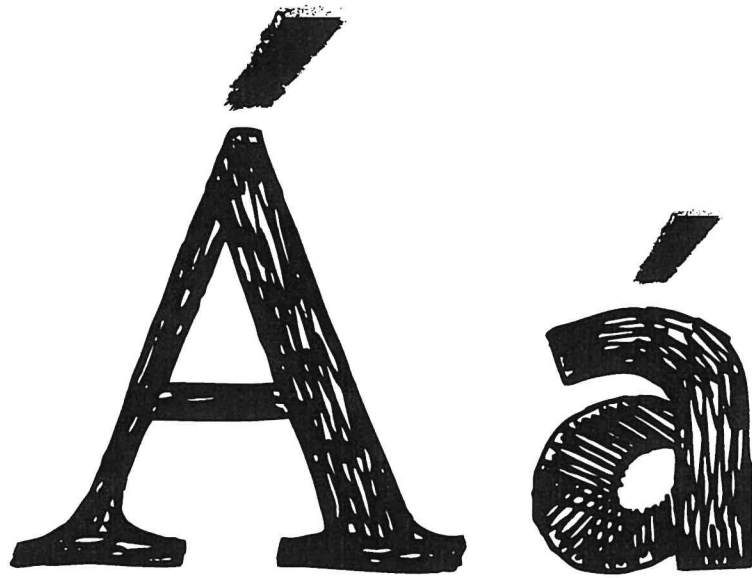

Teldu hvað eru mörg **Á** og **á** í hverri setningu og skráðu fjöldann í kassann fyrir aftan.

Ása sá Ása áðan við ána

Ási sat á steini og sá ekki Ásu

Ása og Ási eru ágætir vinir

Árni og Árný fá ál í net

Árný dró ás og áttu

Áttu ás? spurði Árni Ásu



# Litaðu myndina sem rímar við fyrstu myndina

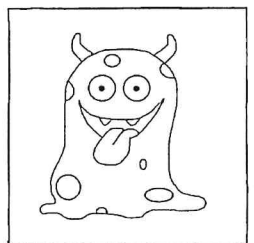
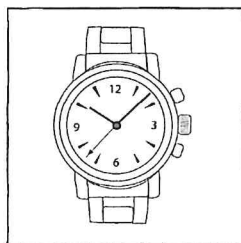
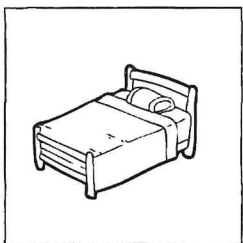
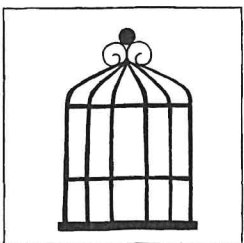
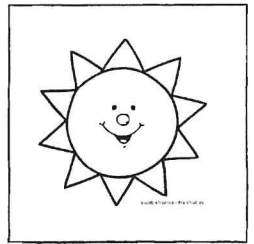
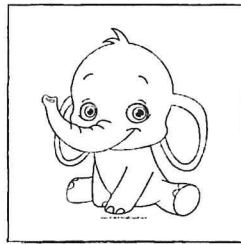
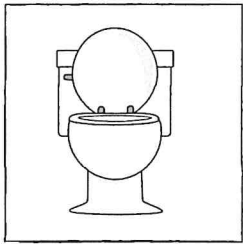
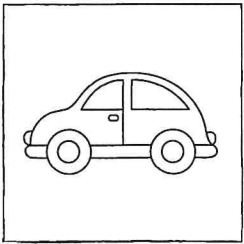
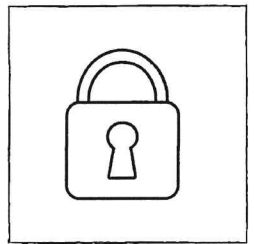
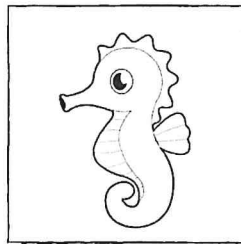
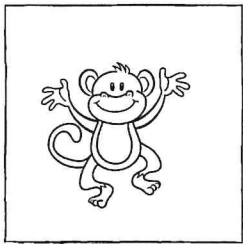
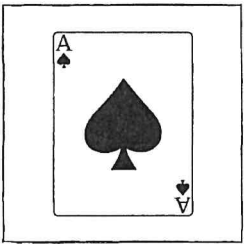
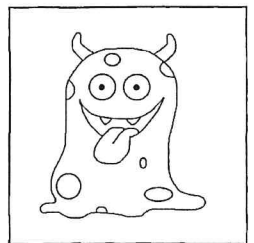
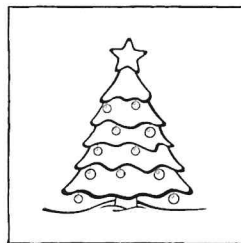
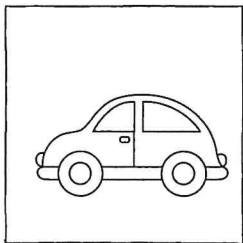
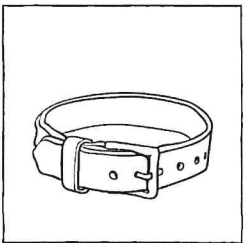
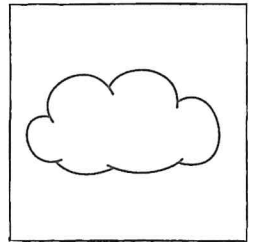
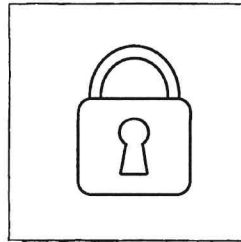
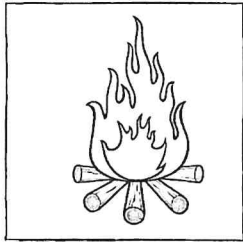
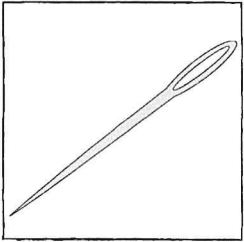
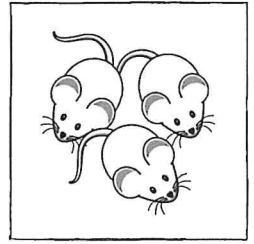
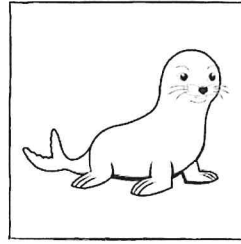
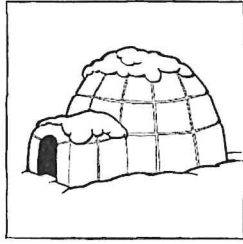

Lestu orðið

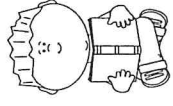

ekki

Skrifaðu orðið

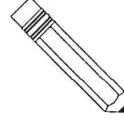

ekki

Skrifaðu orðið

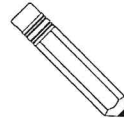

ekki

Litaðu orðið



ekki

Klappaðu orðið



ekki

1

2

3



Finndu orðið

ekki - hún - aftur -  
aldrei - fór - ekki - hann  
- hann - ekki - það -

Dragðu hring utan um orðið

Hún fór ekki út.

Hún fór ekki heim.



lesa

Ss

spora

Ss

skrifa

-----

-----

-----

leira eða byggja

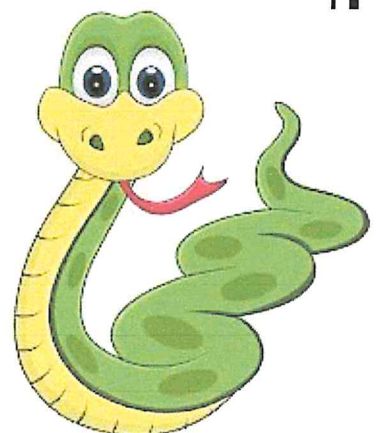

# Klappið atkvæði og litið jafnmarga hringi



Four empty circles for counting.

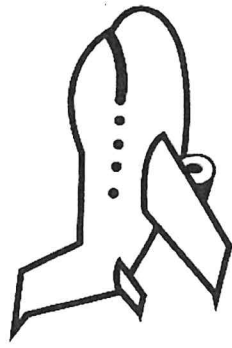

Four empty circles for counting.

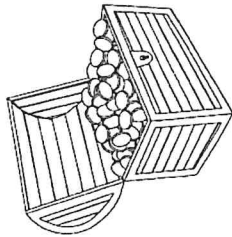

Four empty circles for counting.

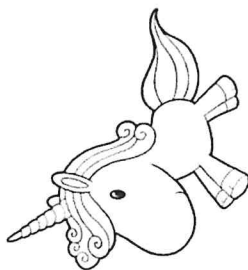

Four empty circles for counting.

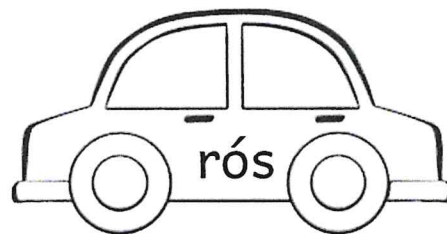
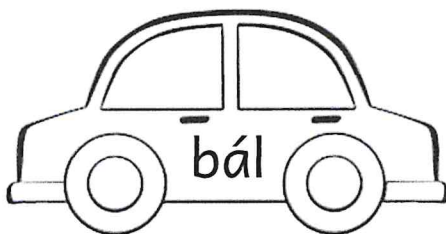
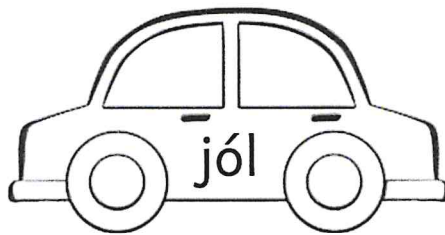
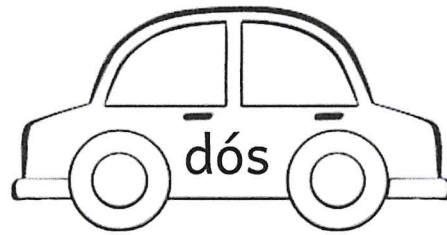
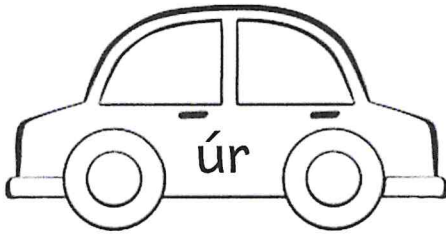
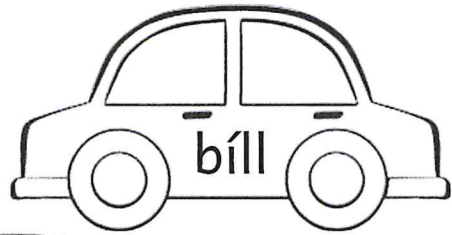
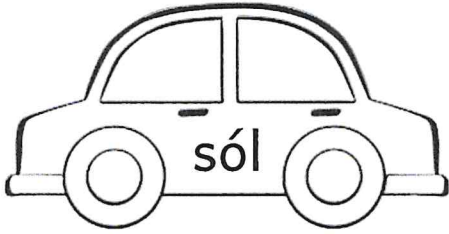

Lestu orðin á bílunum og litaðu þá bíla sem ríma saman í sama lit

## 7. S s

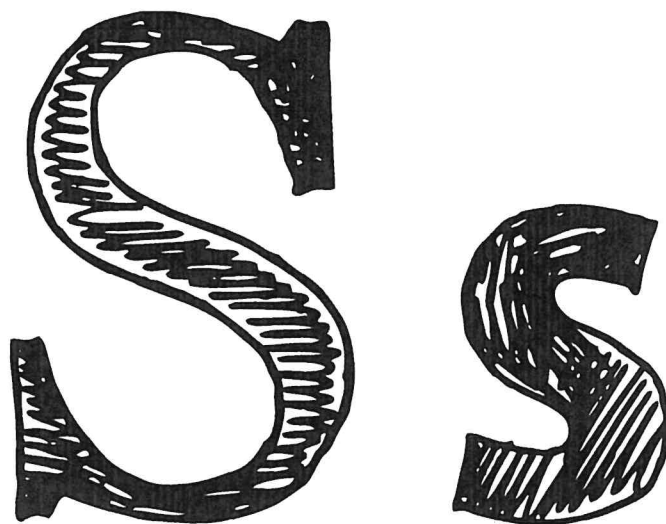

Gerðu hring um öll s.

Stebbi sá sel í sumar.

Sara og Sunna sáu sama sel.

Selir synda í sjónum.

Segðu mér sögu, sagði Sara við Sínu.

Sína sagði Söru sögu um sel.

Sá selur hét Snorri.

Finndu/teiknaðu mynd og kláraðu að skrifa setningarnar.

Ég á

Ég á

Ég á

Ég á

Nemandi skoðar myndaspjöldin, velur mynd og klárar setninguna.  
Hann getur einnig teiknað sína eigin mynd og klárað setninguna.



lesa

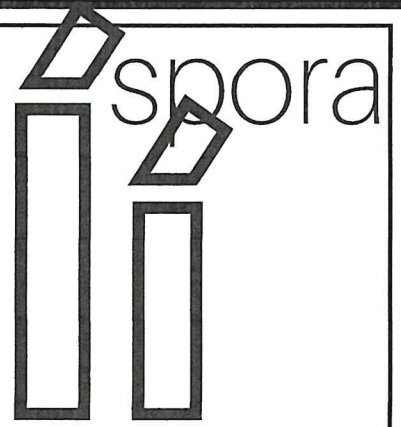
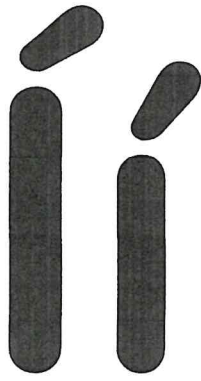

skrifa

-----

-----

-----

leira eða byggja





## 4. Í í

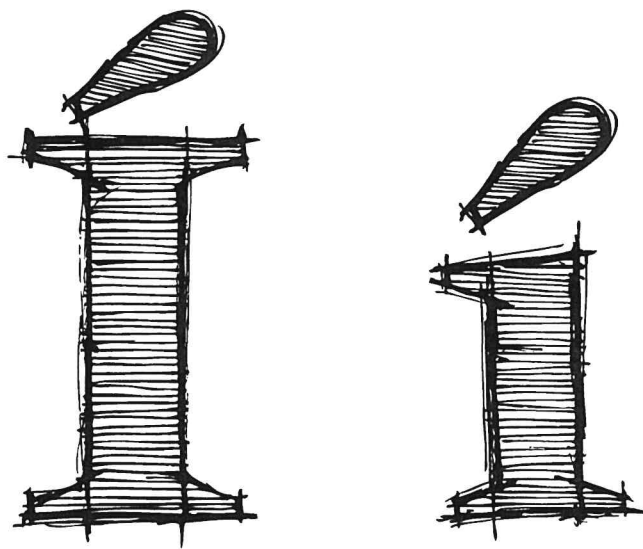

Gerðu hring um orðin sem hafa í sér Í eða í.

ís

vísa

saga

tíu

rófa

vol

Ívar

tölva

Ída

Ísak

haus

hilla

sími

happ

hríð

Íris

Gerðu hring um orð sem hafa hljóðið í í sér.



# Klappið atkvæði og litid jafnmarga hringi

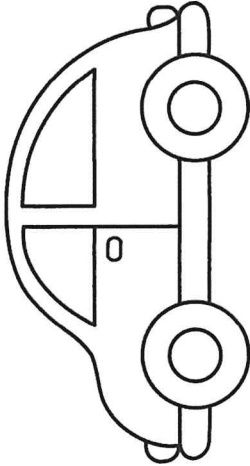

Four empty circles for coloring.

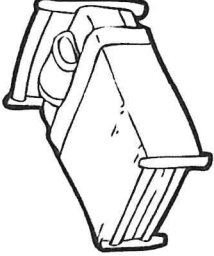

Four empty circles for coloring.

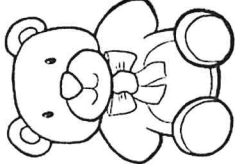

Four empty circles for coloring.

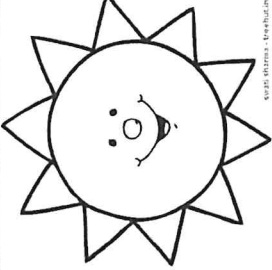

Four empty circles for coloring.

### Fyrsti stafur í orði

Við hverja mynd vantar fyrsta bókstafinn til að lesa orðið sem á að vera þar. Bókstafirnir eru neðst á blaðsíðunni. Klipptu þá út og límdu á línuna sem er fyrir aftan hverja mynd. Lestu svo orðið.



\_\_\_\_\_ *efur*

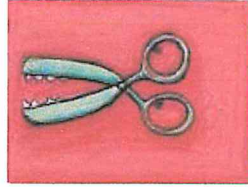

\_\_\_\_\_ *kæri*



\_\_\_\_\_ *anna*

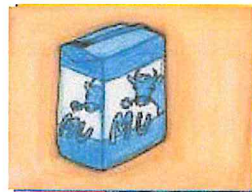

\_\_\_\_\_ *jólk*



\_\_\_\_\_ *ampi*



\_\_\_\_\_ *rani*



\_\_\_\_\_ *rmur*



\_\_\_\_\_ *úkka*

*l*

*p*

*s*

*d*

*k*

*o*

*r*

*m*

Kláraðu að skrifa setningarnar og teiknaðu/finndu rétta mynd

Þetta er sól.

Þetta er lás.

Þetta er rós.



Þetta er api.



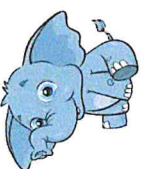

Two empty rectangular boxes for writing.



Two empty rectangular boxes for writing.



Two empty rectangular boxes for writing.



Two empty rectangular boxes for writing.

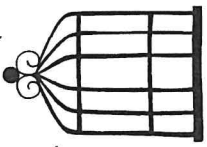

Two empty rectangular boxes for writing.

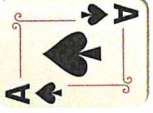

Two empty rectangular boxes for writing.

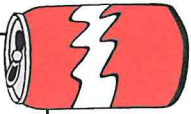



lesa

Aa

spora

Aa

skrifa

Handwriting practice lines consisting of three horizontal dashed lines.

leira eða byggja



## 6. A a

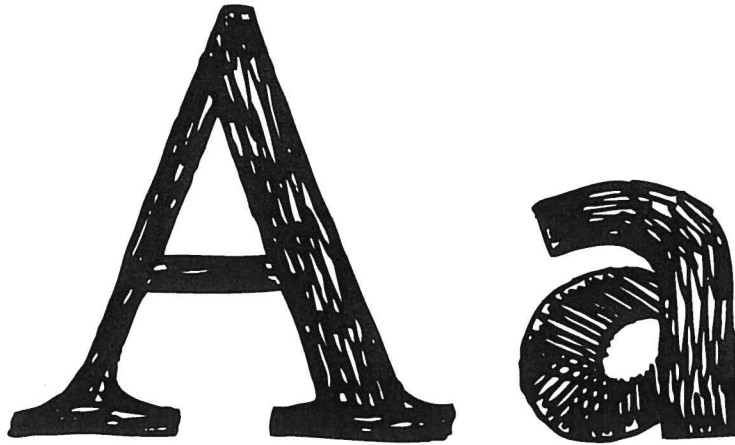

Gerðu hring um orðin sem byrja á **A** og **a**.

poki	hús	kýr	afi
vél	api	Ari	dós
bók	aka	þota	Anna

Gerðu hring um orðin sem enda á **a**.

dyr	fata	leka	vor
apa	kot	bíll	húfa
mamma	gata	rúm	olía

## Fyrsti stafur í orði

Við hverja mynd vantar fyrsta bókstafinn til að lesa orðið sem á að vera þar. Bókstafirnir eru neðst á blaðsíðunni. Klipptu þá út og límdu á línuna sem er fyrir aftan hverja mynd. Lestu svo orðið.



\_\_\_\_\_

ykill

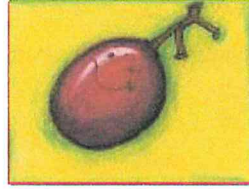

\_\_\_\_\_

ínber



\_\_\_\_\_

undur



\_\_\_\_\_

rúður



\_\_\_\_\_

reiða



\_\_\_\_\_

lauta

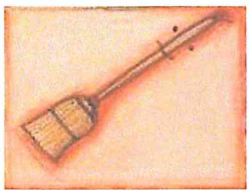

\_\_\_\_\_

ústur



\_\_\_\_\_

krúfa

l

t

g

f

k

h

s

v

Finndu/teiknaðu mynd og kláraðu að skrifa setningarnar.

Þetta er

Þetta er

Þetta er

Þetta er

Nemandi skoðar myndaspjöldin, velur mynd og klárar setninguna.  
Hann getur einnig teiknað sína eigin mynd og klárað setninguna.

Lestu orðið

sagði

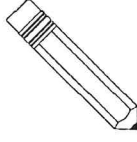
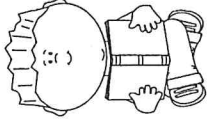

Skrifaðu orðið

sagði

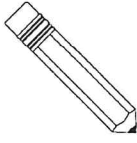

Skrifaðu orðið

sagði

Litaðu orðið



Sagði

Klappaðu orðið



sagði

1

2

3

Finndu orðið



þangað - sagði - ekki -

sagði - fór - sagði -

alltaf - aldrei - sagði

Dragðu hring utan um orðið

Hún sagði mamma

Lóa sagði lús